



**DANGER**

**Danger of electrical shock, burns or death.** Always remove all power sources before attempting any repair, service or diagnostic work. Power can be present from shore power, generator, inverter or battery. All power sources must be disabled and secured before performing any service.



**CAUTION**

If you lack the skills, tools or equipment to perform diagnostic or repair work leave such work to an authorized Winnebago Industries dealer or other qualified shop.



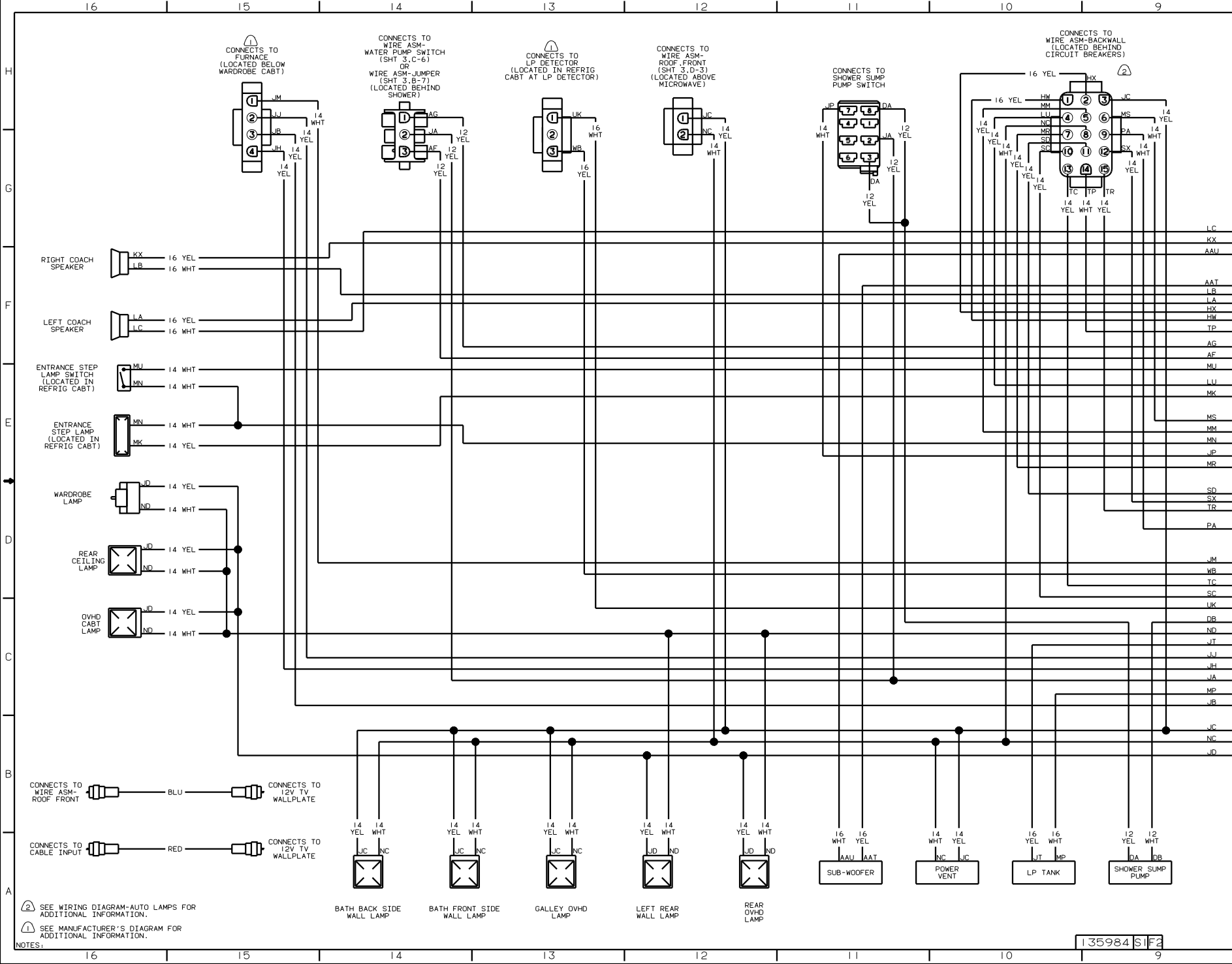

② SEE WIRING DIAGRAM-AUTO LAMPS FOR ADDITIONAL INFORMATION.  
 ① SEE MANUFACTURER'S DIAGRAM FOR ADDITIONAL INFORMATION.



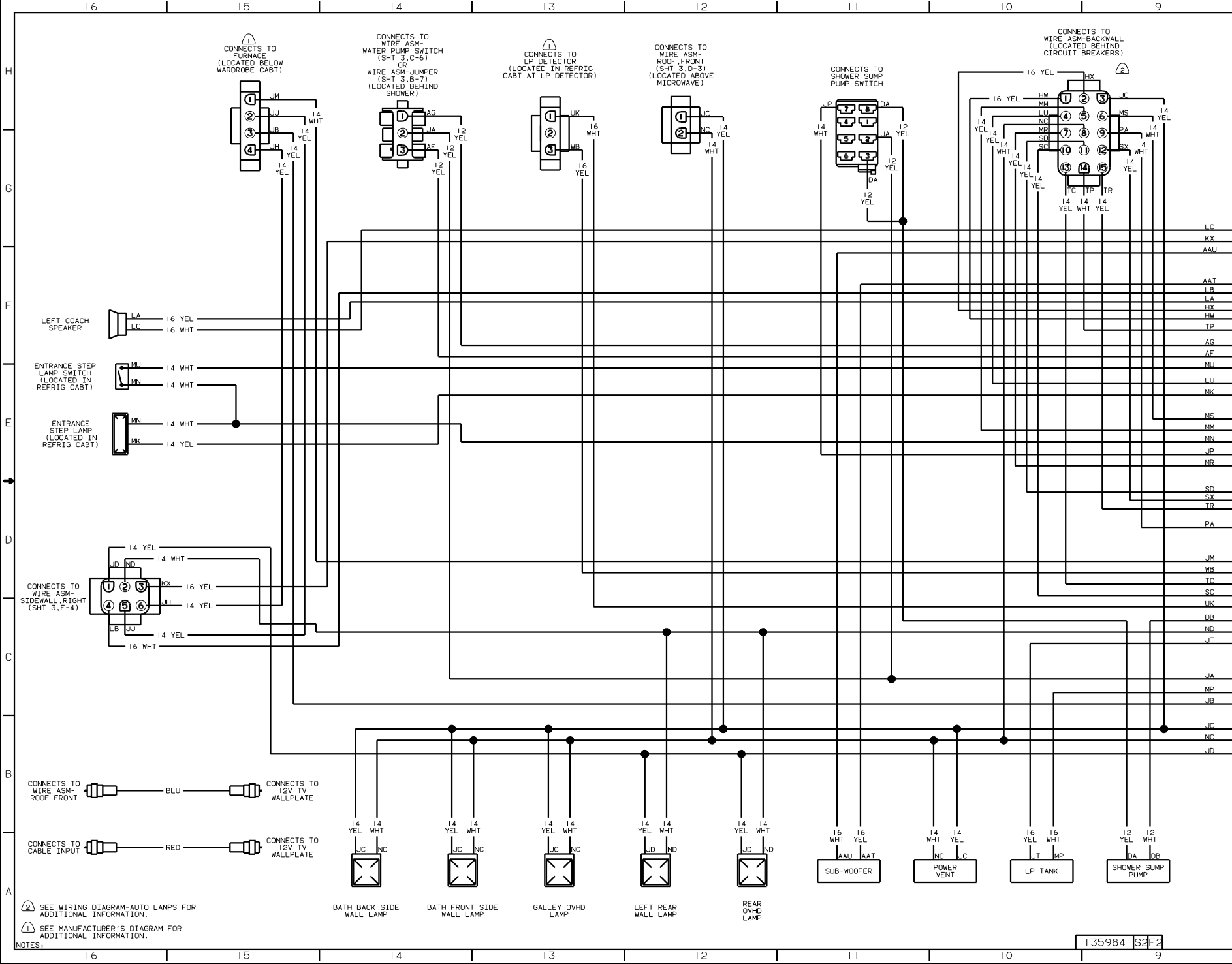

CONNECTS TO FURNACE (LOCATED BELOW WARDROBE CABT)

CONNECTS TO WIRE ASM- WATER PUMP SWITCH (SHT 3.C-6) OR WIRE ASM-JUMPER (SHT 3.B-7) (LOCATED BEHIND SHOWER)

CONNECTS TO LP DETECTOR (LOCATED IN REFRIG CABT AT LP DETECTOR)

CONNECTS TO WIRE ASM- ROOF FRONT (SHT 3.D-3) (LOCATED ABOVE MICROWAVE)

CONNECTS TO SHOWER SUMP PUMP SWITCH

CONNECTS TO WIRE ASM-BACKWALL (LOCATED BEHIND CIRCUIT BREAKERS)

LEFT COACH SPEAKER  
LA 16 YEL  
LC 16 WHT

ENTRANCE STEP LAMP SWITCH (LOCATED IN REFRIG CABT)  
MU 14 WHT  
MN 14 WHT

ENTRANCE STEP LAMP (LOCATED IN REFRIG CABT)  
MN 14 WHT  
MK 14 YEL

CONNECTS TO WIRE ASM- SIDEWALL RIGHT (SHT 3.F-4)  
JD 14 YEL  
ND 14 WHT  
KX 16 YEL  
JH 14 YEL  
LB 14 YEL  
JU 16 WHT

CONNECTS TO WIRE ASM- ROOF FRONT  
CONNECTS TO 12V TV WALLPLATE

CONNECTS TO CABLE INPUT  
CONNECTS TO 12V TV WALLPLATE

BATH BACK SIDE WALL LAMP

BATH FRONT SIDE WALL LAMP

GALLEY OVHD LAMP

LEFT REAR WALL LAMP

REAR OVHD LAMP

SUB-WOOFER

POWER VENT

LP TANK

SHOWER SUMP PUMP

- LC
- KX
- AAU
- AAT
- LB
- LA
- HX
- HW
- TP
- AG
- AF
- MJ
- LU
- MK
- MS
- MM
- MN
- JP
- MR
- SD
- SX
- TR
- PA
- JM
- WB
- SC
- UK
- DB
- ND
- JT
- JA
- MP
- JB
- JC
- NC
- JD

NOTES:  
 (2) SEE WIRING DIAGRAM-AUTO LAMPS FOR ADDITIONAL INFORMATION.  
 (1) SEE MANUFACTURER'S DIAGRAM FOR ADDITIONAL INFORMATION.

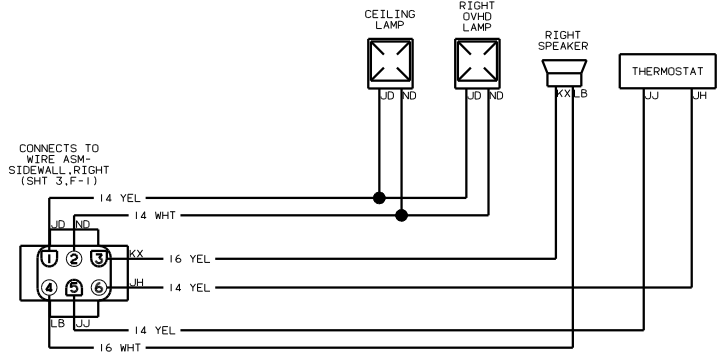

WIRING DIAGRAM-OVHD (WIRE ASM 119701)

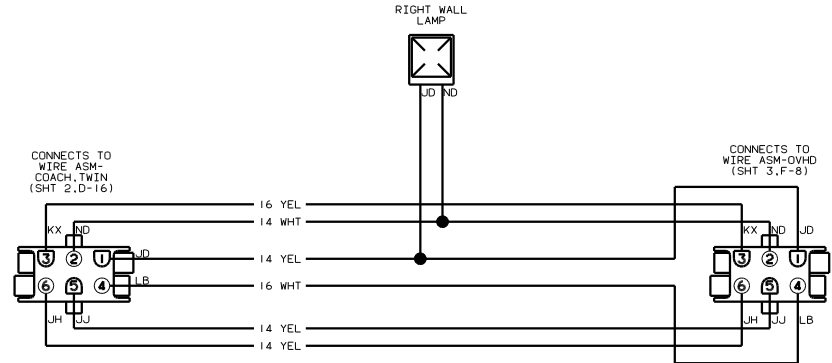

WIRING DIAGRAM-SIDEWALL, RIGHT (WIRE ASM 119702)

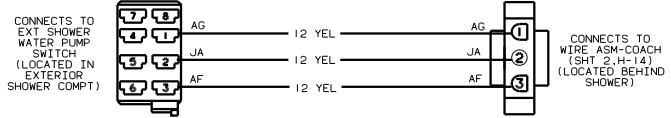

WIRING DIAGRAM WATER PUMP, SWITCH (WIRE ASM 103494-04) (WITH EXTERIOR SHOWER)

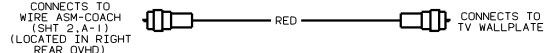
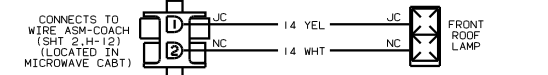

WIRING DIAGRAM-ROOF, FRONT (WIRE ASM 133878)

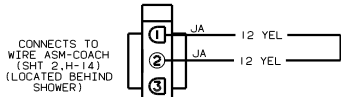

WIRING DIAGRAM-JUMPER (WIRE ASM 103493) (WITHOUT EXTERIOR SHOWER)