



DANGER

Danger of electrical shock, burns or death. Always remove all power sources before attempting any repair, service or diagnostic work. Power can be present from shore power, generator, inverter or battery. All power sources must be disabled and secured before performing any service.



CAUTION

If you lack the skills, tools or equipment to perform diagnostic or repair work leave such work to an authorized Winnebago Industries dealer or other qualified shop.

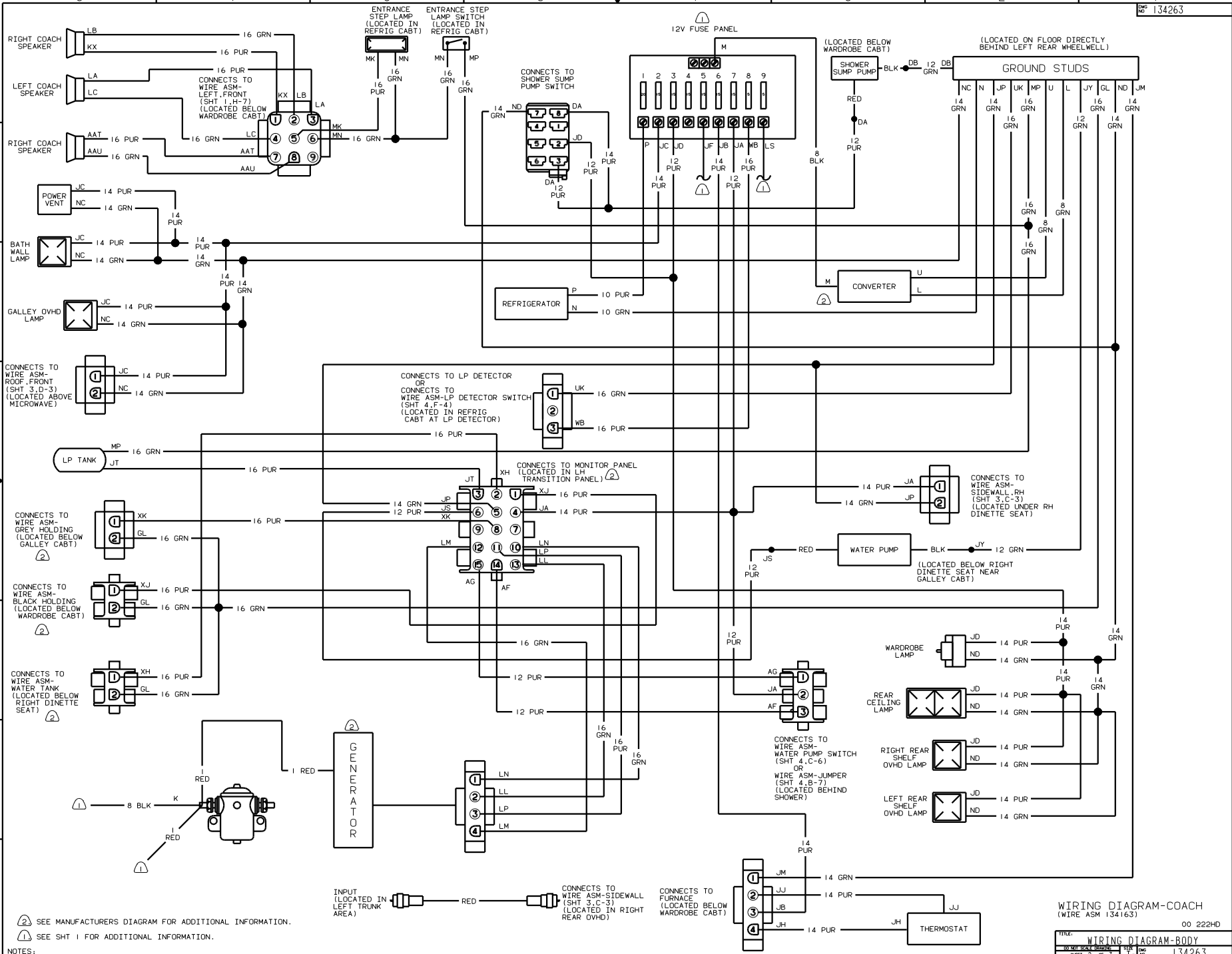

② SEE MANUFACTURERS DIAGRAM FOR ADDITIONAL INFORMATION.
 ⚠ SEE SHT 1 FOR ADDITIONAL INFORMATION.

WIRING DIAGRAM-COACH
 (WIRE ASM 134163)

00 222HD
 TITLE: WIRING DIAGRAM-BODY
 SHEET 2 OF 3

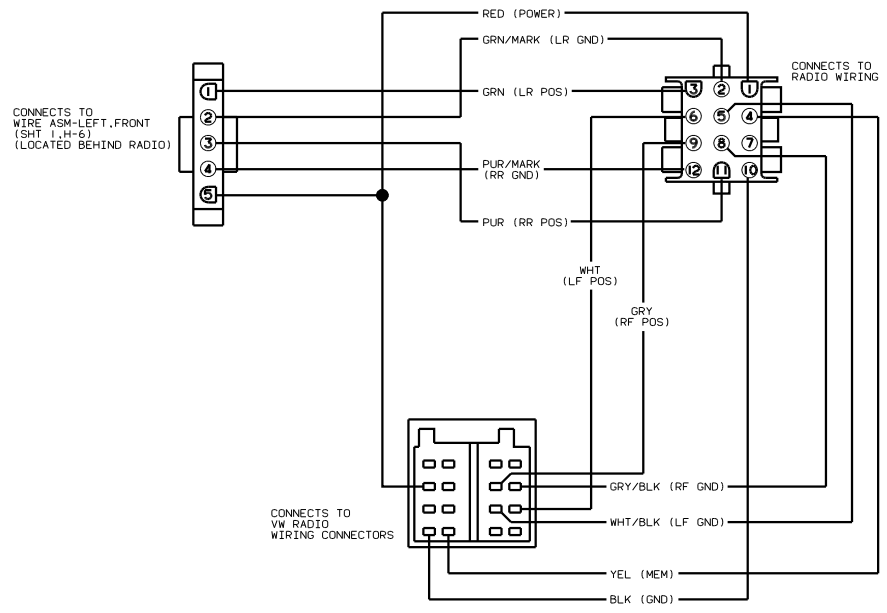

WIRING DIAGRAM-ADAPTER,RADIO
(WIRE ASM 114365-02)

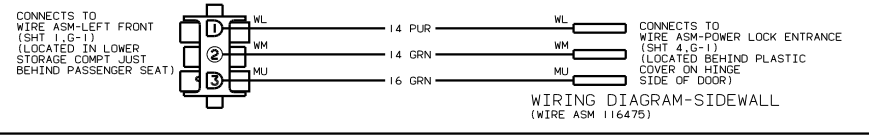

WIRING DIAGRAM-SIDEWALL
(WIRE ASM 116475)

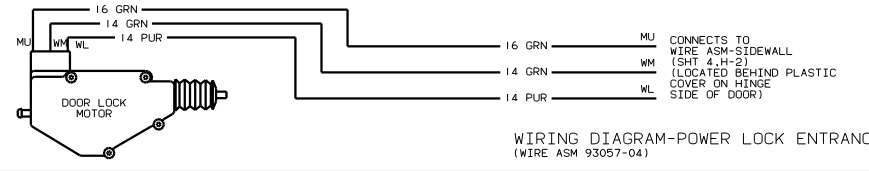

WIRING DIAGRAM-POWER LOCK ENTRANCE
(WIRE ASM 93057-04)

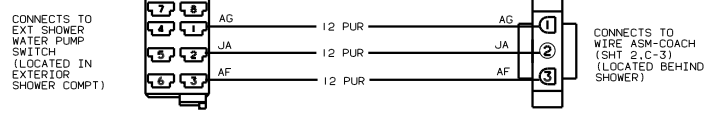

WIRING DIAGRAM WATER PUMP,SWITCH
(WIRE ASM 103494-04)
(WITH EXTERIOR SHOWER)

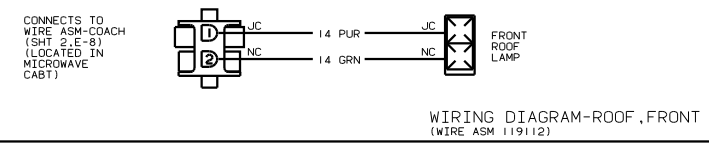

WIRING DIAGRAM-ROOF,FRONT
(WIRE ASM 119112)

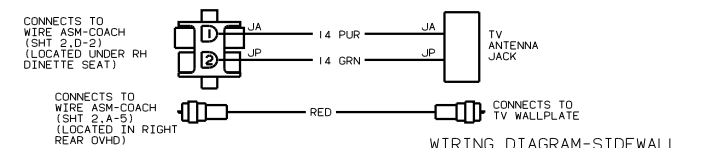

WIRING DIAGRAM-SIDEWALL
(WIRE ASM 111451-03)

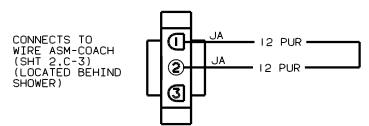

WIRING DIAGRAM-JUMPER
(WIRE ASM 103493)
(WITHOUT EXTERIOR SHOWER)