



**DANGER**

**Danger of electrical shock, burns or death.** Always remove all power sources before attempting any repair, service or diagnostic work. Power can be present from shore power, generator, inverter or battery. All power sources must be disabled and secured before performing any service.



**CAUTION**

If you lack the skills, tools or equipment to perform diagnostic or repair work leave such work to an authorized Winnebago Industries dealer or other qualified shop.

CONNECTS TO WIRE ASM-WATER TANK (LOCATED BELOW RIGHT DINETTE SEAT)

CONNECTS TO WIRE ASM-BLACK HOLDING (LOCATED BELOW WARDROBE CABT)

CONNECTS TO WIRE ASM-GREY HOLDING (LOCATED BELOW GALLEY CABT)

CONNECTS TO MONITOR PANEL (LOCATED IN LH TRANSITION PANEL)

CONNECTS TO WIRE ASM-LEFT, FRONT

CONNECTS TO REAR AUTO HEATER

CONNECTS TO WIRE ASM-LEFT, FRONT

CONNECTS TO WIRE ASM-LEFT, FRONT

12V FUSE PANEL

COPYRIGHT 2002 WINNEBAGO INDUSTRIES, INC. WINNEBAGO 03 222FD	
DPTTR	DATE UNDESPECIFIED TOLERANCES ARE: MATERIAL:
CHR	DATE SINGLE DIM (X.X) +
P E	DATE ONE-PLACE (X.XX) +
M E	DATE TWO-PLACE (X.XXX) +
DSCR	DATE ANGLE
	DATE THIRD ANGLE PROJECTION
LAYOUT NO	TITLE: WIRING DIAGRAM-BODY, 12V
DIA #	SCALE: NOTE DO NOT SCALE DRAWING SIZE: 11.000
ALL DIMENSIONS ARE IN MILLIMETERS	SHEET 1 OF 3 I.F. NO 141391

WIRING DIAGRAM-COACH, DOUBLE (WIRE ASM 141387)

CONVERTER (LOCATED ON FLOOR DIRECTLY BEHIND LEFT REAR WHEEL WELL)

CONNECTS TO GENERATOR

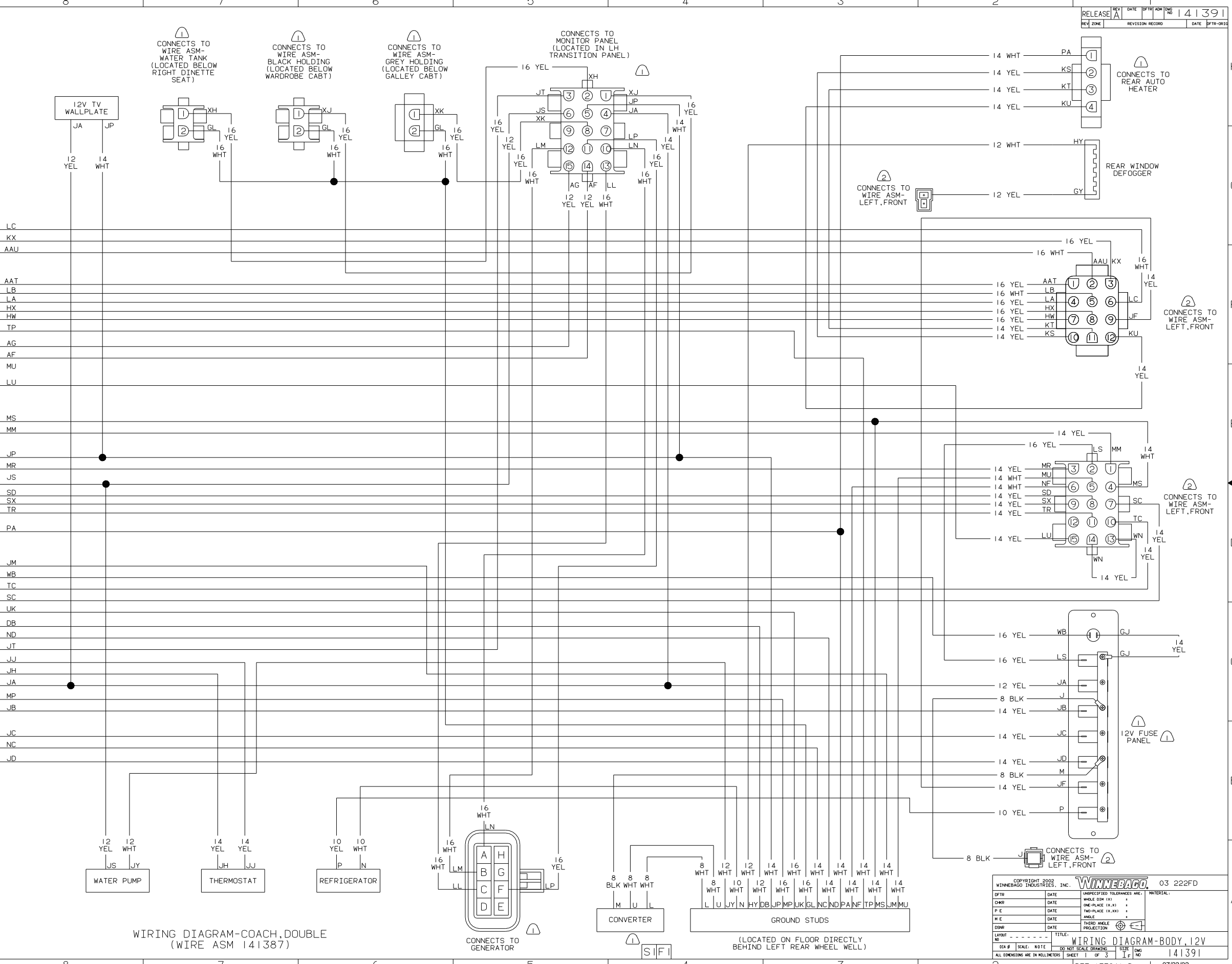

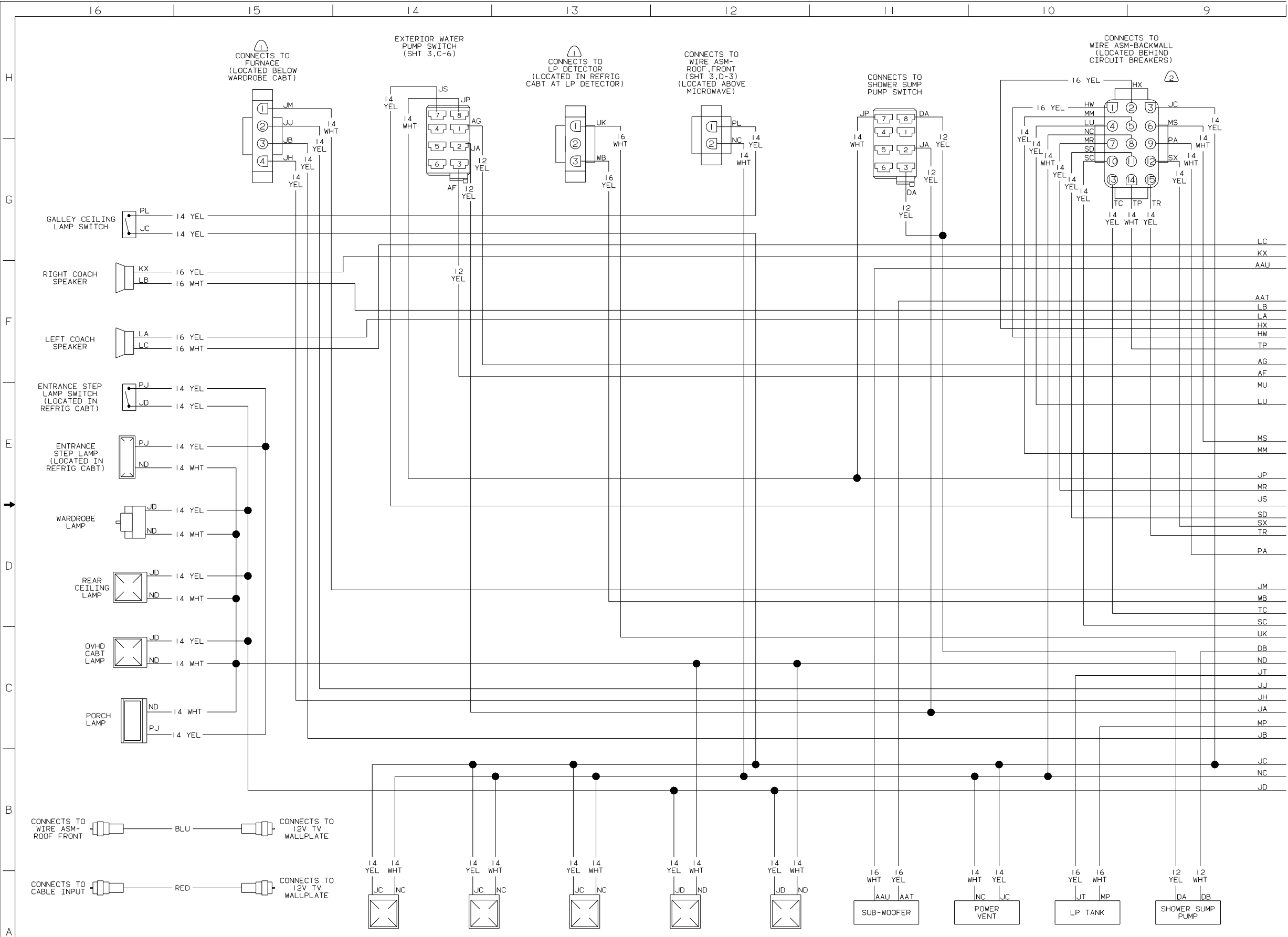

② SEE WIRING DIAGRAM-AUTO LAMPS FOR ADDITIONAL INFORMATION.  
 ① SEE MANUFACTURER'S DIAGRAM FOR ADDITIONAL INFORMATION.

NOTES:

CONNECTS TO WIRE ASM- WATER TANK (LOCATED BELOW RIGHT DINETTE SEAT)

CONNECTS TO WIRE ASM- BLACK HOLDING (LOCATED BELOW WARDROBE CABT)

CONNECTS TO WIRE ASM- GREY HOLDING (LOCATED BELOW GALLEY CABT)

CONNECTS TO MONITOR PANEL (LOCATED IN LH TRANSITION PANEL)

CONNECTS TO REAR AUTO HEATER

CONNECTS TO WIRE ASM- LEFT, FRONT

CONNECTS TO WIRE ASM- LEFT, FRONT

CONNECTS TO WIRE ASM- LEFT, FRONT

12V FUSE PANEL

CONNECTS TO WIRE ASM- LEFT, FRONT

12V TV WALLPLATE

WATER PUMP

REFRIGERATOR

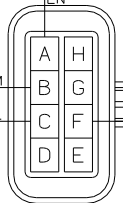

CONNECTS TO GENERATOR

CONVERTER

GROUND STUDS

(LOCATED ON FLOOR DIRECTLY BEHIND LEFT REAR WHEEL WELL)

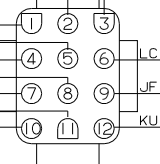

REAR WINDOW DEFOGGER

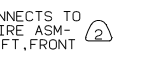
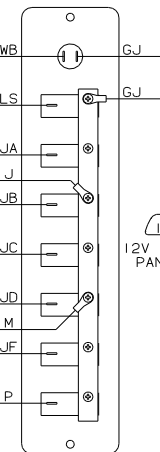
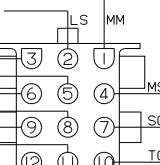
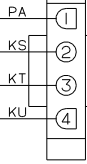
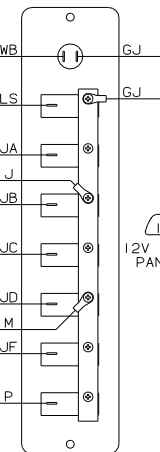
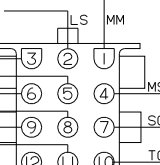

WIRING DIAGRAM-COACH, TWIN (WIRE ASM 141388)

03 222FD

TITLE: WIRING DIAGRAM-BODY, 12V	
DO NOT SCALE DRAWING	SIZE: 11x17
SHEET 2 OF 3	IF: No 141391

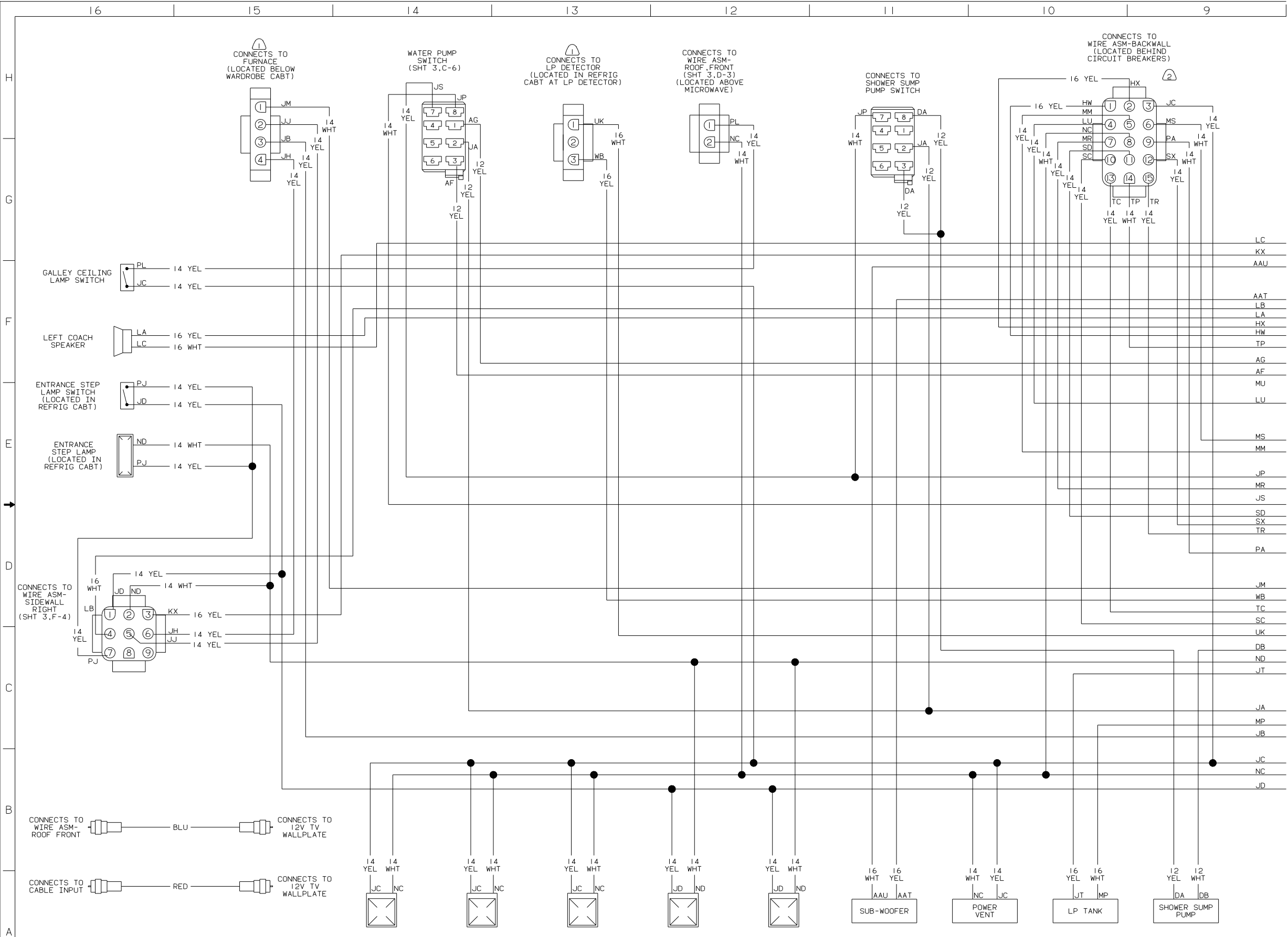

NOTES:  
 (2) SEE WIRING DIAGRAM-AUTO LAMPS FOR ADDITIONAL INFORMATION.  
 (1) SEE MANUFACTURER'S DIAGRAM FOR ADDITIONAL INFORMATION.

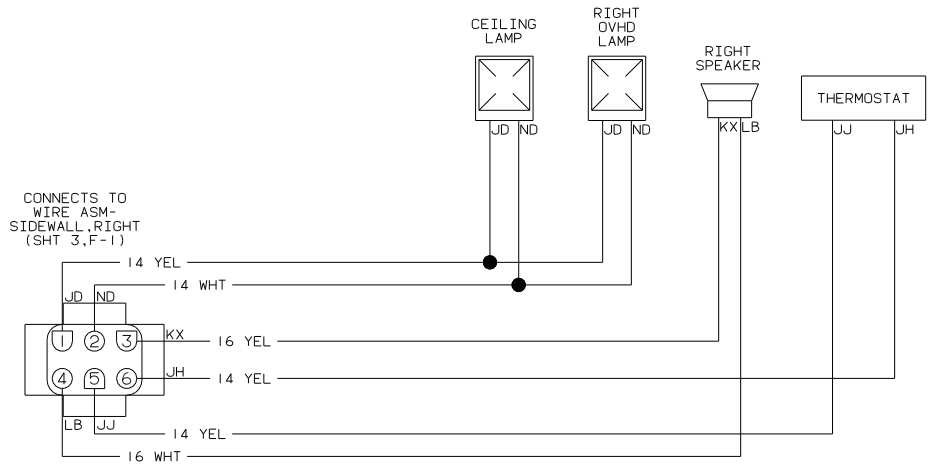

WIRING DIAGRAM-OVHD (WIRE ASM 119701)

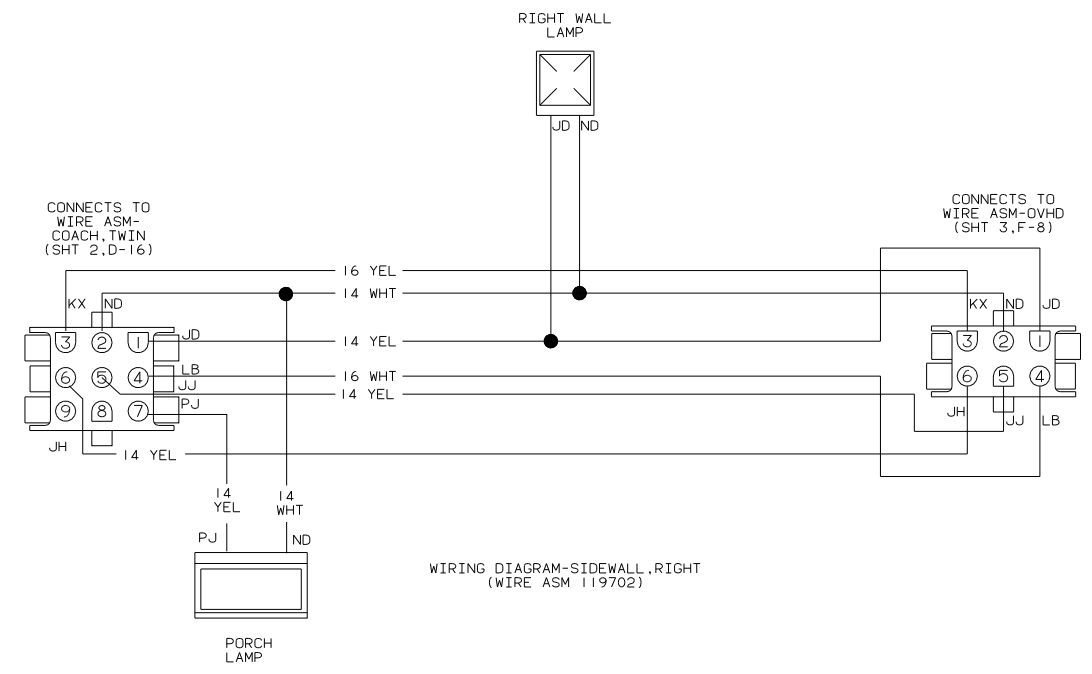

WIRING DIAGRAM-SIDEWALL, RIGHT (WIRE ASM 119702)



WIRING DIAGRAM-ROOF, FRONT (WIRE ASM 133878)